



INTELLiPH[®] ACID DISPENSER SYSTEM



INSTALLATION AND USER'S GUIDE

IMPORTANT SAFETY INSTRUCTIONS
READ AND FOLLOW ALL INSTRUCTIONS
SAVE THESE INSTRUCTIONS

Technical Support

Phone: (800) 831-7133 - Fax: (800) 284-4151

Web sites: www.pentairpool.com and www.staritepool.com:

Contents

IMPORTANT WARNINGS AND SAFETY INSTRUCTIONS.....	i
IntellipH System Overview	1
Operating IntellipH	1
IntellipH Kit Contents	1
IntellipH Controller Control Panel	2
Operating Mode	3
Enter Button	3
Menu Button	3
Add Acid Manually.....	3
Dispense Amount	4
Superchlor Mode	5
Set Cell Output.....	5
Cell Status.....	5
History Data.....	5
Troubleshooting	6
How to refill the IntellipH canister	6
IntellipH Installation	7
Setting up the system for the first time	7
Operation with IntelliTouch and EasyTouch Automation Systems	7
IntellipH Installation	8
Saddle Clamp Mount Installation	9
Pump Head Tube Replacement Instructions	10
Replacing the Chemical Tubing	11
IntellipH Chemical Controller and Canister Replacement Parts	13

**READ AND FOLLOW ALL INSTRUCTIONS IN
THIS MANUAL**

IMPORTANT WARNINGS AND SAFETY INSTRUCTIONS

WARNING Most states and local codes regulate the construction, installation, and operation of public pools and spas, and the construction of residential pools and spas. It is important to comply with these codes, many of which directly regulate the installation and use of this product. Consult your local building and health codes for more information.



IMPORTANT NOTICE - Attention Installer: This Installation and User's Guide ("Guide") contains important information about the installation, operation and safe use of this product. This Guide should be given to the owner and/or operator of this equipment.

WARNING Before installing this product, read and follow all warning notices and instructions in this Guide. Failure to follow warnings and instructions can result in severe injury, death, or property damage. Call (800) 831-7133 for additional free copies of these instructions. Please refer to www.pentairpool.com for more information related to this product.

WARNING Working with muriatic acid can be dangerous. When cleaning the IECG always wear rubber gloves and eye protection. Always add acid to water, do not add water to acid. Always work in a well-ventilated area. Splashing or spilling acid can cause severe personal injury and/or property damage. **Pentair always recommends 1:1 dilution when using full strength muriatic acid. When mixing, remember to always add acid to water.**

IMPORTANT! TAKE EXTREME CARE WHEN INSERTING THE ACID CONTAINER INTO THE STORAGE TANK, AS THE FOIL SEAL MAY NOT BE FULLY ATTACHED.

WARNING Be sure that the pool or spa meets the requirements of the current National Electrical Code (N.E.C.) Article 680-22 and all local codes and ordinances. A licensed or certified electrician must install the electrical system to meet or exceed those requirements before this product is installed.

⚠ DANGER



READ THE FOLLOWING BEFORE HANDLING AND WORKING WITH MURIATIC ACID (ALSO KNOWN AS HYDROCHLORIC ACID) AND CHLORINE (SODIUM HYPOCHLORITE)

MURIATIC ACID AND CHLORINE (LIQUID AND MIST) CAN CAUSE SEVERE BURNS TO SKIN, MOUTH AND EYES. MAY BE FATAL IF SWALLOWED OR INHALED. INHALATION CAN CAUSE SEVERE LUNG DAMAGE.

IMPORTANT WARNINGS AND SAFETY INSTRUCTIONS

READ AND FOLLOW ALL INSTRUCTIONS SAVE THESE INSTRUCTIONS



INHALATION

Inhalation of vapors can cause coughing, inflammation of the nose, throat and upper respiratory tract infection, and death. In case of inhalation, move to an area of fresh air immediately.

INGESTION

Swallowing can be fatal. Contact local poison control center or physician immediately. Give large amounts of water or milk. Allow person to vomit. If vomiting occurs, keep head lower than hips to avoid aspiration. If person is unconscious, turn their head to the side. Seek immediate medical attention.

STORAGE

Store container and acid in a dry, ventilated place protected from excess heat and direct sunlight. The container should be stored at a temperature below 80°F (26°C).

SKIN CONTACT

Wash skin with soap and water for at least 20 minutes and remove contaminated clothing and shoes. Contaminated clothes should be thoroughly cleaned before re-use.

EYE CONTACT

Flush eyes immediately with water for at least 20 minutes. Seek immediate medical attention.

PERSONAL PROTECTION

VENTILATION

Use container outside and in a well-ventilated area.

EYE PROTECTION

Use splash-resistant safety goggles.

CLOTHING

Wear chemical-resistant clothing when handling or working with chlorine.

GLOVES

Wear chemical-resistant gloves when handling or working with chlorine.

DISPOSAL

Because of its corrosive nature, muriatic acid is a hazardous waste when spilled or discarded. Dispose of used acid at an approved hazardous waste facility or at your municipal household hazardous waste collection facility. Small spills of acid may be neutralized using baking soda. Carefully pour the baking soda onto the spilled material until the fizzing stops, then mop or scoop up the residue. Leave cleanup of large spills to the experts; call your local fire department or hazardous materials spill team.

IntellipH® Acid Dispenser System Overview

This manual describes how to install and setup the IntellipH® Acid Dispenser System which consists of the IntellipH controller and dispenser container.

Operating IntellipH® Controller

The IntellipH controller adds acid to the pool every hour. The dispense amount is based on the user's settings. The amount of acid added each hour can be quickly changed by pressing either the MORE or LESS button with a range of 1% - 100% in 1% increments. If 0% is selected, no acid will be dispensed.

All acid for the IntellipH acid dispenser system is stored in a four gallon storage canister with a built-in pump. The acid is pumped from the canister via a tube that is provided in the kit. The tube is attached to a saddle clamp which is mounted after the heater directly into the water return line.

After each dose, the IntellipH controller control panel display will show a 60-minute countdown timer. When the timer equals zero, the pump on the canister is activated and acid is pumped into the pool's main waterline. The 60 minute timer will restart again.

Note: After an IntelliChlor® Salt Chlorine Generator (SCG) is connected to the IntellipH controller, the cell sanitizer output will be adjusted through the IntellipH controller menu and **NOT through the IntelliChlor SCG cell**. Set the IntelliChlor SCG output from the **SET CELL OUTPUT** menu on the IntellipH controller. The **More and Less** buttons on IntelliChlor cell will be disabled.

IntellipH Acid Dispenser System Kit Contents

- One IntellipH Controller Control Panel
- 3-1/2 gallon storage canister, with pump
- 15 ft Acid resistant tubing from canister to cell
- Two saddle clamps (1.5" and 2")
- One Injection fitting

Annual Tube Replacement

IMPORTANT NOTICE: It is recommended to replace the pump head tube once a season (yearly), see page 10 for pump head tube replacement instructions.

Annual Feed Line Inspection

Annually inspect the 1/4" feed line. Replace if required.

IntellipH® Controller Control Panel

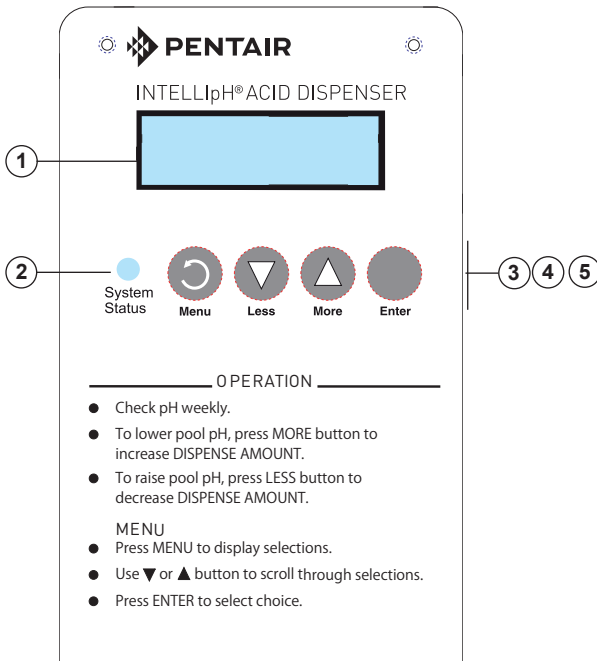

- ① **Liquid Crystal Display (LCD):** The system LCD displays backlighting for easy viewing of the menu items and status messages. Each button press will light the display. When an event message is displayed, the backlight also lights.
- ② **System Status LED indication:** Shows green when the system is running normally and red if an error occurred. See page 6 for error conditions.
- ③ **Menu/Button:** Access and exit from the menu. While in a menu or sub-menu, use this button to go back to a previous menu level or item. If no menu activity is detected after 30 seconds, the main screen is displayed. All menu settings are permanently saved and retained in the control panel even after the IntellipH® Controller is powered off.
- ④ **Less / More buttons:** Scroll through the main menu items and adjust or change settings. Use these buttons after pressing the Menu button to scroll through the main menu items.
- ⑤ **Enter button:** Select a menu choice or save changes. While system is in normal mode, press this button to show the system settings. The display will automatically revert back to the normal display mode after 30 seconds from the last selection.

Operating Mode

In normal operating mode, the display will alternate between “IntelliPH pH CONTROLLER” and “MIN UNTIL NEXT DISPENSE”. Each message is displayed a few seconds before rotating to the next message. The “XX” is a minute countdown timer that counts down from 60 to 00.

IntelliPH
pH CONTROLLER

XX MIN UNTIL
NEXT DISPENSE

ENTER button

If the ENTER button is pressed during normal display mode, the system information is displayed for four seconds:

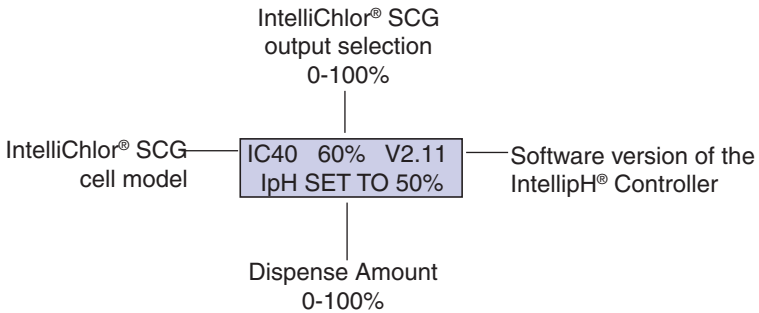

Menu Button

Press the MENU button to display the system choices. Use the MORE or LESS button to scroll through each choice. Press the ENTER button to select that choice. Pressing the MENU button will exit that menu.

Add Acid Manually

When this selection is displayed, press the ENTER key to begin dispensing acid. The pump will turn on for 60 seconds and a countdown timer will be displayed along with a running total of acid being dispensed. Approximately 4 oz. of acid will be dispensed.

If the acid hose has air bubbles, the amount pumped will be slightly less than amount displayed on the LCD screen. Press the ENTER key at any time to exit this mode. If the ENTER key is not depressed, the system will return to normal operation after the 60 seconds has elapsed.

Dispense Amount

Pressing either the MORE or LESS button, will display the following:

DISPENSE AMOUNT
50% ■■■ _ _ _

This setting controls the acid dose size every hour, and it has a range of 0-100%. The initial factory setting is at 50%. Increasing this percentage will increase the acid dispense amount that occurs every 60 minutes. Decreasing this percentage will decrease the acid dispense amount. Check the pool pH level weekly and adjust this value accordingly to maintain your pool at a pH between 7.2 to 7.4. Dispense amount can also be accessed through the menu system.

Press the MORE button to raise this percentage, or press the LESS button to lower this percentage. Press the MENU key to exit this mode. The new settings will be saved in memory.

If the water pH is low, press the LESS button to decrease the acid dispensed every hour. Likewise, if the water pH is high, press the MORE button to increase the acid dispensed every hour.

IntellipH® Controller is designed to maintain pH levels. If the pH is too high, utilize the manual acid dispense to stabilize your pool and then operate for at least one week under the new settings and re-check the pool water pH level.

It may take several weeks of adjusting the dispense percentage before a final setting is attained for your pool. Bather load, organic loads, filter pump time, and amount of chlorine produced all affect the pH level.

Data is in ounces based on Pump and IPH setting		IPH Percentage Setting		
		10%	50%	100%
Pump Hours	1 hr	0.213	1.065	2.13
	2 hr	0.426	2.13	4.26
	3 hr	0.639	3.195	6.39
	4 hr	0.852	4.26	8.52
	5 hr	1.065	5.325	10.65
	6 hr	1.278	6.39	12.78
	7 hr	1.491	7.455	14.91
	8 hr	1.704	8.52	17.04

Approximate Ounces of ACID Dispensed			
	10%	50%	100%
7 days at 8 hrs. a day	11.928	59.64	119.28
28 days at 8 hrs. a day	47.712	238.56	477.12

Note: 128 Oz. = 1 Gallon

Superchlor Mode

This mode sets the IntelliChlor® SCG output to 100% for 24 hours of pump time.

Note: “Superchlor” mode is equivalent to “Boost” mode in stand-alone operation for IntelliChlor® SCG. In “Superchlor” mode, the pool filter pump is not controlled by the IntellipH® Controller.

Set Cell Output

This setting controls IntelliChlor SCG sanitizer output and has a range of 0% -100%. The default factory setting is 60%. Increasing or decreasing the cell output percentage will increase or decrease chlorine production in your pool.

This feature replaces the MORE and LESS button on the IntelliChlor SCG. When the IntelliChlor SCG is connected to IntellipH controller, the “More” and “Less” buttons on the IntelliChlor SCG are disabled.

Cell Output	LED's Displayed	IntelliChlor SCG “Sanitizer Output” LED Display
0	0	All LEDs are Off
1 - 29		20%
30 - 49	20%	40%
50 - 69	20%, 40%	60%
70 - 89	20%, 40%, 60%	80%
90 - 100	20%, 40%, 60%, 80%	100% (All LEDs are On)

Cell Status

This menu allows you to view the current salinity and temperature of your pool as provided from the IntelliChlor cell.

SALT : Displays the salinity in ppm.

SALT: 4000 PPM

TEMP: Displays the water temperature in °F.

TEMP: 75 F

History Data

The History Data feature allows you to collect and view the operating history of the IntellipH unit. To access the IntellipH (SCG) history data, press ENTER. The following list is displayed:

XXXX DOSES
XXXX DIDN'T DOSE

XXXX DOSES: The number of hourly doses successfully dispensed since installation. Every automatic dispense increments this counter. This feature is useful to verify the unit is dispensing acid.

XXXX DIDN'T DOSE: The number of doses *not* dispensed due to the following conditions:

- **Low Water Temp. (< 52° F)**
- **No Flow**
- **No Communications**
- **Low Salt**
- **Clean Cell**

Troubleshooting

Refer to the following tips to help to resolve problems that might occur while operating the IntelliPH® Acid Dispenser System.

SYMPTOM	POSSIBLE CAUSE	SOLUTION
pH too high in pool	Intelli-pH not "tuned" to pool needs.	Press MORE button to increase Dispense Amount.
pH too low in pool	Intelli-pH not "tuned" to pool needs.	Press LESS button to decrease Dispense Amount.
Acid pump does not run	Hourly acid dose size is too small to dispense every hour. Press MENU, then MANUALLY DISPENSE ACID. This will activate pump.	Increase Dispense Amount setting. Pump not working. Replace pump.
System Status Light is red	Attempted to dispense acid, but no flow was seen in cell. IntelliChlor cell was not ready (IntelliChlor salinity lights scrolling, indicating cell is on status check). Cell communication link is down. Cold Water is < 52°F (12.2°C) or below.	Check and confirm enough water flow through IntelliChlor® SCG. Wait until the IntelliChlor® SCG finishes the 2 min. salinity check cycle. Check terminal block from IntelliTouch® or EasyTouch® Control System. Unit will not dispense.

How to refill the IntelliPH acid canister

To Refill the IntelliPH Acid Canister

Always follow basic safety rules when handling acid. Read and follow the manufactures instructions on the acid container.

- Always wear safety glasses
- Wear rubber gloves
- Refill canister in an open area; not in an enclosed space

To refill the acid canister:

- Refill the canister by carefully and slowly tilting the tip the canister into the acid tank then push down to puncture the foil. To speed up acid dispersal into the tank, use a sharp object to puncture the bottom of the gallon of acid.

IntelliPH® Acid Dispenser Installation

Setting up the system for the first time

For best operation, the IntelliPH® Acid Dispenser system should be configured to match your basic acid needs. Perform the following steps to setup the system:

- Use a Test Kit to balance the pool water
- Measure the water pH
- Operate the IntelliPH Acid Dispenser system for one week
- Monitor the pH regularly and adjust the acid dispensing amount using the “More” or “Less” buttons as required.

Operation with IntelliTouch® and EasyTouch® Control System

When the IntelliPH Controller is connected to an IntelliTouch®, EasyTouch® Control System, the IntelliPH Controller monitors the communication link between the IntelliChlor® SCG and the Control System.

When the IntelliChlor SCG is connected to a Control System, the cell sanitizer output will be adjusted through the automation panel menu and NOT from the IntelliChlor SCG control panel. The “MORE and LESS” buttons on IntelliChlor SCG are disabled.

If the Control System sends out a 0% output command to the IntelliChlor SCG, the cell output percentage display will be blank which indicates no chlorine is being produced. The IntelliPH dispenser will display SYSTEM OFF, WILL NOT DISPENSE. No acid will be dispensed during this time.

If the automation panel is in SPA MODE or the IntelliChlor SCG output is set to 1% -5%, the IntelliPH Acid Dispenser will display SPA MODE, WILL NOT DISPENSE. Acid will not be dispensed while this is displayed. This is a safety feature.

IntelliPH® Controller Installation

The IntelliPH® Controller is installed “in series” with the IntelliChlor® SCG. The IntelliChlor® SCG cell cord plugs into the IntelliPH Controller and the IntelliPH Controller plugs into the IntelliChlor Power Center, EasyTouch® or IntelliTouch® Control Systems Load Center power connector.

To install the IntelliPH Controller:

1. Choose a location on a wall or vertical surface near the IntelliChlor SCG power center (P/N 520556) and/or the EasyTouch and IntelliTouch Control System Load Center. Secure the IntelliPH Controller to the surface with the three screws.
2. **WARNING!** SWITCH OFF or REMOVE POWER to the IntelliChlor SCG.
3. Remove the IntelliChlor SCG cell cord from the power center, EasyTouch or IntelliTouch Control System Load Center. Insert the IntelliChlor SCG cell cord plug into the bottom of the IntelliPH Controller.
4. Plug the IntelliPH Controller cord into the IntelliChlor SCG Power Center, IntelliTouch or EasyTouch Control System load center where the IntelliChlor SCG cell originally was plugged in.

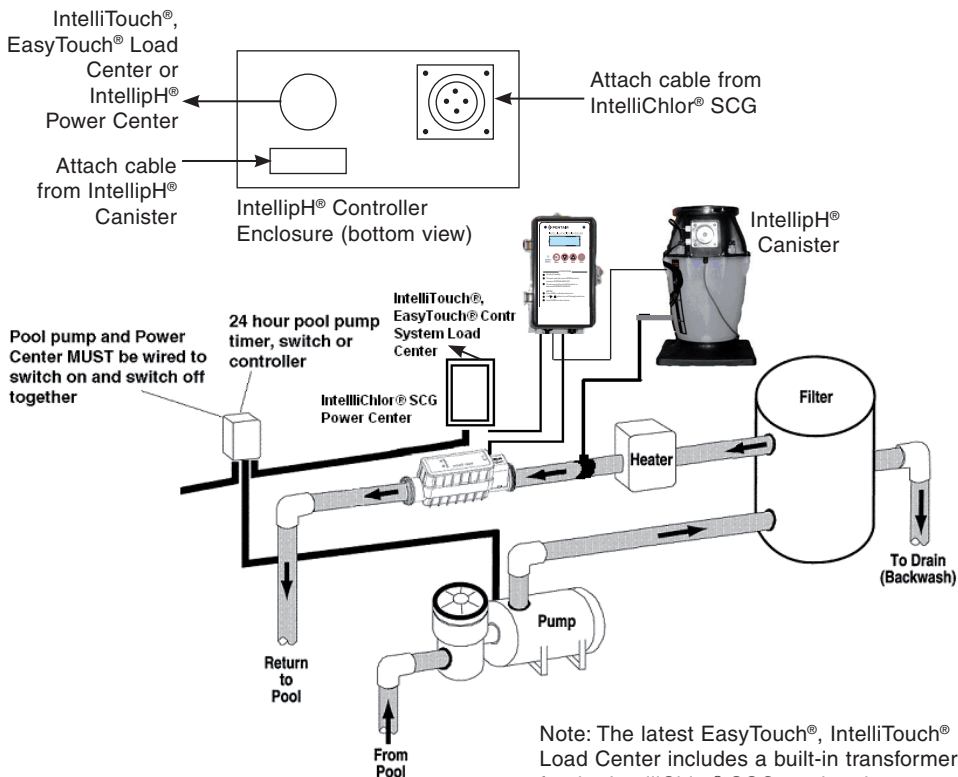

Note: The latest EasyTouch®, IntelliTouch® Load Center includes a built-in transformer for the IntelliChlor® SCG, and no longer requires an IntelliChlor® Power Center.

IntelliPH® Controller Installation Diagram

Saddle Clamp Mount Installation

The saddle clamp is designed to mount the acid injection fitting on the main water return line after the heater. The outside of the pipe must be clean and free of surface imperfections to ensure a leak-free installation.

Drill the Mounting Hole:

1. Select an area on the pipe close to the IntelliChlor® Salt Chlorine Generator (SCG) cell between the filter and IntelliChlor (SCG) cell on the Flow Switch side of the cell inlet.
2. Drill a 1/2" diameter hole through the center of the pipe wall. Be sure not to drill through the pipe.
3. Clean all burrs from inside and outside of the hole. If necessary, use fine sandpaper to remove the burrs.

Install the Saddle Clamp:

1. Thread the injector fitting into the top of the saddle clamp. Place the supplied o-ring in the groove. **IMPORTANT!** Be sure the o-ring is properly aligned in the groove on the saddle clamp.
2. Place the pipe hose clamps around the pipe and the slots on the saddle clamp. Tighten the pipe clamps using the alternative method (i.e. left, right, left, etc.).
3. Insert acid tubing through the supply injector fitting cap. Connect tubing onto the acid injection fitting and tighten cap securely before turning the pump on (See diagram below).
4. The IntelliPH® Acid Dispenser system is now ready for operation.

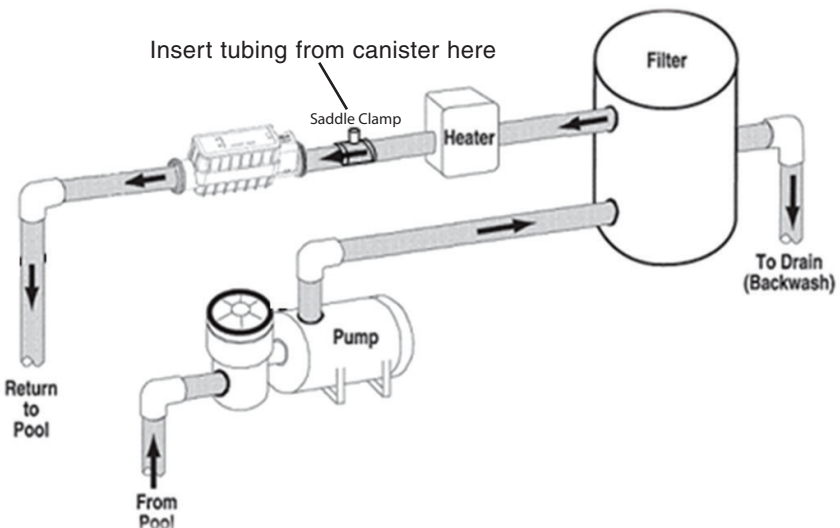

Pump Head Tube Replacement Instruction (for units built after 8/2014)

Before starting the tube replacement procedure, read all safety precautions on page i and ii.

IMPORTANT! Replace the IntellipH pump head tube (P/N 522480) once a season (yearly). For units built before 8/2014, replace the whole pump head (P/N 521514) every season.

To remove the tube from the pump:

1. Pull the lock lever tab 180° from left to right to unlock the cover latch. See Figure 1.
2. Push up on the raised edge of the front cover and slide cover off. See Figure 2.
3. Release the fittings from the slots to remove the tube. See Figure 3.
4. Disconnect the suction and discharge connections from pump head.
5. Remove the roller assembly.
6. Use non-citrus all-purpose cleaner to clean residue from pump head housing, roller, and cover.
7. Check cover for cracks. Replace if cracked (P/N 522386).
8. Ensure rollers spin freely.
9. Note: if the rollers are seized or visibly worn, replace roller assembly.
10. Re-install roller assembly.

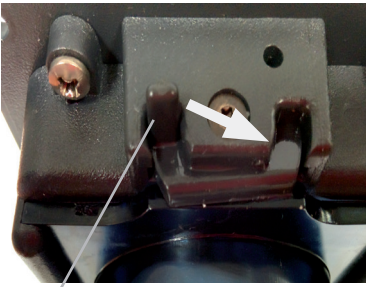

Figure 1.

Pull lock lever tab from left to right side to unlock

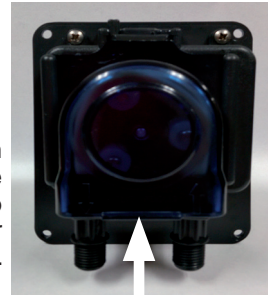

Figure 2.

Push up on raised edge of cover to slide cover off.

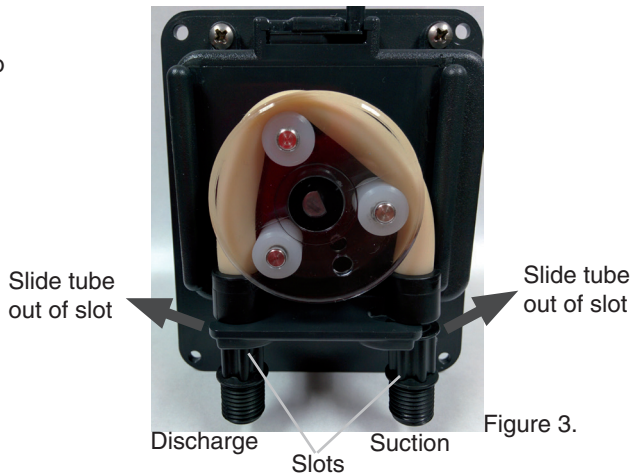

Figure 3.

Pump Head Tube Replacement Instruction (Continued)

Install the New Tube

1. To install new tube, insert one fitting into slot, pull tube around the center of the roller assembly and insert second fitting into the other slot. See Figure 4.
2. Align tube housing cover with track and slide over tube to seat the cover in place. See Figure 5.
3. To lock cover in place, push lock lever down on the cover while turning the vertical tab 180° from right to left. See Figure 6.
4. Reconnect the suction and discharge lines.
5. Prime pump.
6. Rinse the area with water.

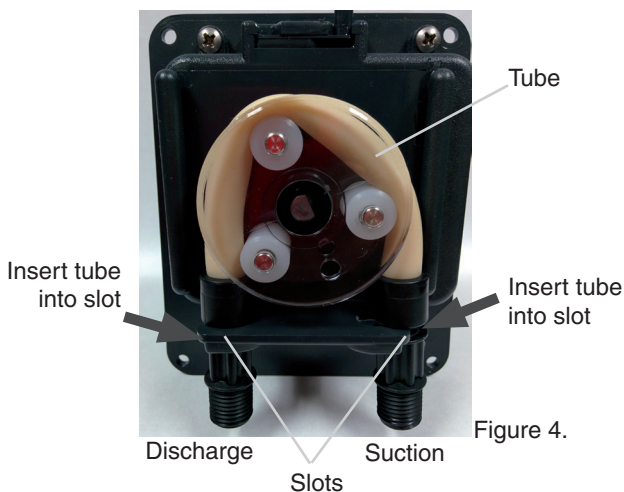

Figure 4.

Push down on top of cover to seat in place

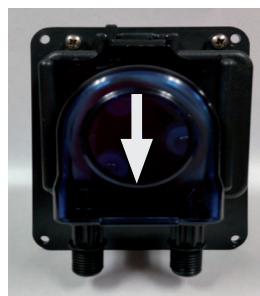

Figure 5.

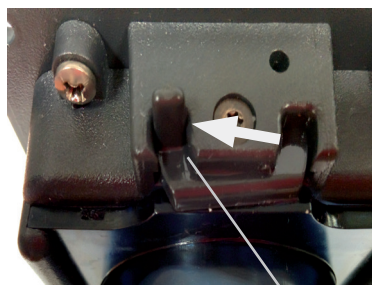

Figure 6.

Push lock lever tab from right to left side to lock in place

Replacing the Chemical Tubing (see illustration on next page)

1. Read and follow the safety instructions given in the MSDS/SDS for the acid. Wear chemical resistant gloves and safety glasses.
2. Inspect the pump head tube, and replace if it is worn or one year old.
3. Remove and properly dispose of the old tubing.
4. Cut approximately 1 ft of tubing to connect the Suction fitting to the Inlet of the pump head. Ensure that the tubing is cut square and the ends are clean. Do not overtighten the nuts, and ensure that the pump head tube is not twisted.
5. Cut enough tubing to connect the Outlet of the pump to the Injection/Check Valve. Ensure that the tubing is routed away from areas where it can be damaged, or would cause damage if it is punctured. Also avoid bending the tubing sharply, especially at the ends. Ensure that the tubing is cut square and the ends are clean. Do not overtighten the nuts, and ensure that the pump tube is not twisted.
6. Prime the tubing by performing a manual dose. Verify the pump head tube stays centered on the rollers, and check for leaks. Rinse the equipment pad with water.



IntellipH® Controller and Chemical Canister Replacement Parts List

IntellipH Controller Replacement Parts

- 1 522711 IntellipH Controller Unit
- 2 521513 Faceplate and PCBA
- 3 521516 Door for Controller

Replacement Chemical Container

- 522712 IntellipH Container

Chemical Container Replacement Parts

- 522384 1/4" Black Tubing for Chemical Injection with Labels, 20 ft
- 522446 1/4" Black Tubing for Chemical Injection with Labels, 100 ft
- 1 522386 Repair Kit for Tank Mounted Pump
- 2 522480 Pump Tubes for Tank Mounted Pump, 2 pack
- 3 522895 Injection Kit (Includes Injection Check Valve)
- 4 521511 Saddle Clamp for 1-1/2" Pipe (Requires Check Valve)
- 5 521512 Saddle Clamp for 2" Pipe (Requires Check Valve)
- 6 522513Z Injection Check Valve
- 7 521505 Lid for Acid Container
- 8 521507 O-ring for Container Lid, 5 pack
- 9 521508 Suction Fitting, Black
- 10 521509 Vent Fitting, Grey
- 521514 SHURflo Pumphead for IntellipH Controller (prior to 2014)
- 521515 Motor for IntellipH with SHURflo Pumphead

IntellipH® Controller and Chemical Canister Replacement Parts

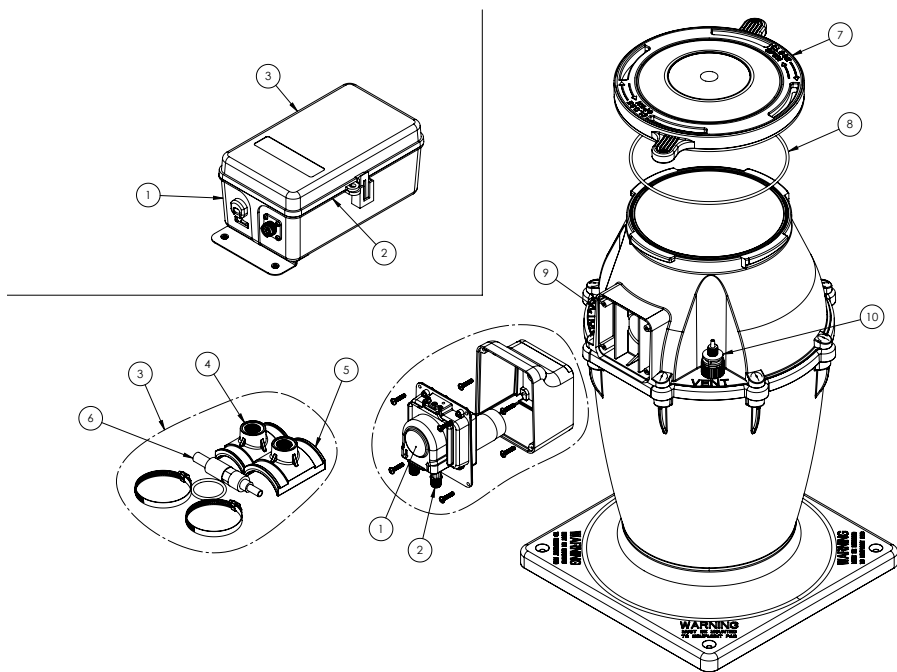



WATER SOLUTIONS

1620 HAWKINS AVE., SANFORD, NC 27330 • (919) 566-8000
10951 WEST LOS ANGELES AVE., MOORPARK, CA 93021 • (805) 553-5000

www.pentairpool.com

All Pentair trademarks and logos are owned by Pentair or by one of its global affiliates. Pentair Aquatic Systems™, IntellipH®, EasyTouch®, IntelliTouch®, and IntelliChlor® are trademarks and/or registered trademarks of Pentair Water Pool and Spa, Inc. and/or its affiliated companies in the United States and/or other countries. Unless expressly noted, names and brands of third parties that may be used in this document are not used to indicate an affiliation or endorsement between the owners of these names and brands and Pentair Water Pool and Spa, Inc. Those names and brands may be the trademarks or registered trademarks of those third parties. Because we are continuously improving our products and services, Pentair reserves the right to change specifications without prior notice. Pentair is an equal opportunity employer.

© 2015 Pentair Water Pool and Spa, Inc. All rights reserved.
This document is subject to change without notice.



P/N 521396 REV F 9/2015